

**MIMO**

FROM **mura**flex

**MIMO**

MIMO from Muraflex.

Minimal. Modern. And so much more.

MIMO de Muraflex.

Minimal. Moderne. Et bien plus encore.

# DEMOUNT ABLE PARTI TIONS



# CLOISONS AMOVIBLES

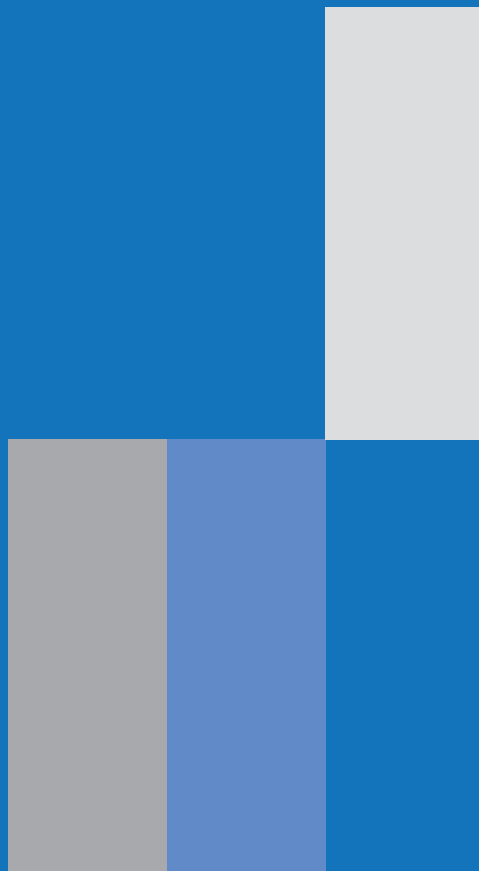

Let in more light. Show off architectural elements. Change your floorplan at will. MIMO from Muraflex is not only the most slender and sophisticated demountable wall solution, but also the most versatile, flexible, and convenient. Made from fully recyclable aluminum, frames are available in innumerable colors and finishes and can accept an endless variety of wall materials. Best of all, we are so close and so quick, you'll have elegance on site in half the time you'd expect. All it takes is your ideas and our hardware.

MIMO. Put less between you and your vision.

Laissez entrer la lumière. Affichez l'architecture. Changez votre environnement de travail à votre convenance. MIMO de Muraflex n'est pas seulement le mur démontable le plus raffiné et élégant, mais également le plus versatile, flexible et pratique. Fabriqué à partir d'aluminium entièrement recyclable, les extrusions sont disponibles dans d'innombrables couleurs et finis. Ils peuvent accepter une variété de verres et de panneaux muraux.

MIMO élargit votre vision.

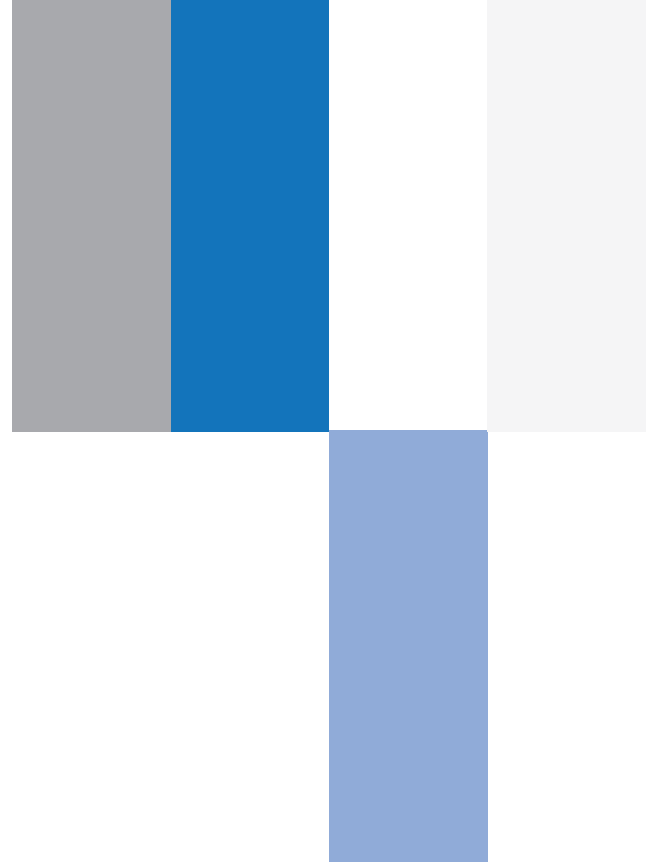





# MODU LAR MODU LAIRE

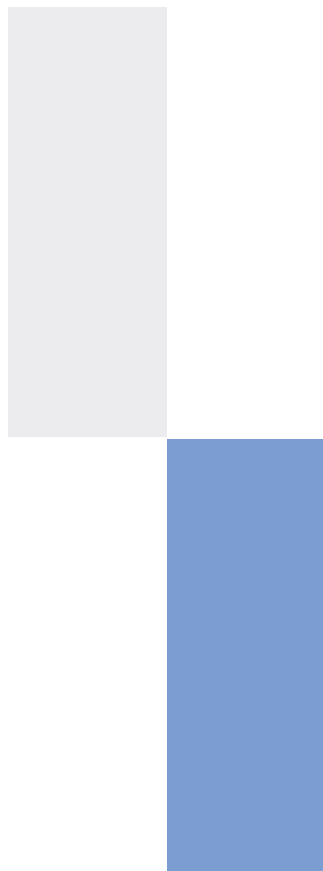

MIMO is a true demountable wall system. Which means it is installed over existing flooring, accommodates all kinds of doors and storage systems, can be fully wired and can be easily moved and reconfigured. So if you staff up, you can switch it up. If you change your mind, you can change your walls. With MIMO, you not only get the most minimal frame, you also get the least amount of fuss.

MIMO est un véritable mur démontable. Étant installé sur le couvre plancher existant, MIMO peut facilement être déplacé et reconfiguré. Il peut également accommoder tous les types de portes. Qu'elles soient coulissantes; battantes; à charnières; à pivots; en verre ou en bois. MIMO peut également inclure des systèmes électriques modulaires ainsi que le câblage réseau et la téléphonie. Si vous changez d'idée, vous pouvez changer vos murs à votre guise. Avec MIMO vous n'avez pas seulement un minimum de pièces, vous avez un minimum de dérangement lors de l'installation ou de la reconfiguration.







# MATE RIALS MATE RIAUX





As long as it can be glazed, we can make a wall out of it. Which means your options are almost endless. And MIMO frames come in any of 17 carefully-selected, design-savvy standard finishes and colors; custom colors are limited only by your imagination. Most important, because our frame and brackets are so slim, you'll see more of whatever material you choose.

11

Du moment que vous utilisez des matériaux allant de  $\frac{1}{4}$ " à  $\frac{3}{4}$ " nous pouvons en faire une cloison. En verre, bien sûr, mais également en polycarbonate, en bois, en tissus, en acier, en aluminium peint, en mélamine, en gypse peint, ou avec un tableau marqueur. Ce ne sont que quelques exemples, la limite est votre imagination. Tous ces matériaux peuvent s'insérer dans nos extrusions qui sont disponibles dans 17 couleurs et textures soigneusement choisies. Il est également possible de personnaliser la couleur des extrusions et, parce que nos pièces sont si fines, vous verrez beaucoup plus les matériaux que vous aurez choisi.

**GLASS PANELS**

CLEAR TEMPERED  
FROSTED  
LAMINATED  
LOW IRON  
ULTRA CLEAR  
STAR FIRE  
WRITEABLE  
ETC

**VERRE**

TREMPÉ CLAIR  
DÉPOLI A L'ACIDE  
ULTRA CLAIR  
LAMINÉ  
SÉRIGRAPHIE  
VERRE A AFFICHAGE  
ETC

**SOLID PANELS**

WOOD VENEER  
FABRIC TACK  
PLASTIC LAMINATE  
ACRYLIC  
DECOR METAL  
DRYWALL COVERED  
WITH VINYL  
PAINTED DRYWALL  
ETC

**PANNEAUX**

PLACAGE DE BOIS  
PANNEAUX RECOUVERTS  
DE TISSUS  
MÉLAMINE  
MÉTAL DÉCORATIF  
GYPSE PEINT  
GYPSE RECOUVERT  
DE VINYLE  
ETC

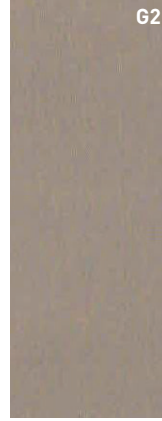
**EXTRUSIONS**  
**EXTRUSIONS****MATE**  
**RIALS**  
**MATE**  
**RIAUX****G1**  
**ANODIZED CLEAR**  
**ANODISÉ CLAIR****G2**  
**ANODIZED CHAMPAGNE**  
**ANODISÉ CHAMPAGNE****G2**  
**ANODIZED LIGHT BRONZE**  
**ANODISÉ BRONZE PÂLE****G2**  
**ANODIZED BLACK**  
**ANODISÉ NOIR****G2**  
**ANODIZED POLISHED ALUMINUM**  
**ANODISÉ ALUMINIUM POLI****G4**  
**ANODIZED ARCHITECTURAL BRONZE**  
**ANODISÉ BRONZE ARCHITECTURAL****G4**  
**ANODIZED MEDIUM BRONZE**  
**ANODISÉ BRONZE MEDIUM**



63

**FAUX BOIS LIGHT OAK**  
**FAUX BOIS CHÊNE BLANC**



63

**FAUX BOIS DOUGLAS FIR**  
**FAUX BOIS SAPIN DE DOUGLAS**



63

**FAUX BOIS WARM CHERRY**  
**FAUX BOIS CERISIER RECONFORTANT**



63

**FAUX BOIS CHESTNUT**  
**FAUX BOIS CHÂTAIGNIER**



63

**FAUX BOIS WALNUT**  
**FAUX BOIS NOYER**

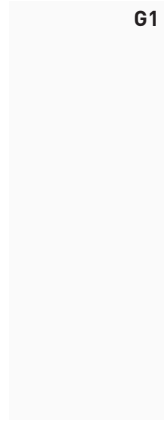

61

**POWDER COAT BRIGHT WHITE**  
**PEINTURE BLANC ÉCLATANT**

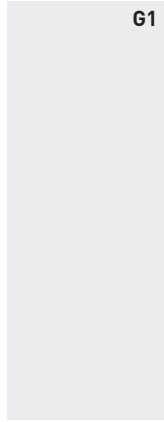

61

**POWDER COAT LIGHT GRAY**  
**PEINTURE GRIS PÂLE**



61

**POWDER COAT TAUPE**  
**PEINTURE TAUPE**



61

**POWDER COAT CHARCOAL**  
**PEINTURE CHARBON**



62

**POWDER COAT CUSTOM COLOR**  
**PEINTURE COULEUR PERSONNALISÉE**

MANAG  
EABLE  
MANI  
ABLE









■ MONTREAL, QUEBEC

330 MILES FROM NYC

■ 2,474 MILES FROM LA

■ TORONTO

■ CHICAGO, IL ■

■ BOSTON, MA

■ SEATTLE, WA

■ KANSAS CITY, MO ■

■ NEW YORK, NY

■ PHILADELPHIA, PA ■

■ WASHINGTON, DC

■ LOS ANGELES, CA

■ DALLAS, TX

■ AUSTIN, TX ■

■ HOUSTON, TX

■ ORLANDO, FL

■ FT LAUDERDALE, FL

■ MIAMI, FL



**OTHER  
DEMOUNTABLE PARTITIONS**

4,022 MILES FROM NYC

■ 6,472 MILES FROM LA

**MIMO is flexible, but so is Muraflex.**

We have showrooms in key major North American metropolitan areas, so you can see for yourself what's possible. We also have a complete engineering staff that can make even the most unique ideas come to life, quickly. And with our super tight lead times, you can get a distinctive, European look.

**MIMO est polyvalent, tout comme**

**Muraflex.** Nous avons des salles de montres dans les plus grosses villes en Amérique du Nord pour que vous puissiez voir nos possibilités. Nous avons une équipe complète d'ingénieurs pour rendre possibles toutes vos idées originales et ce, rapidement. Avec nos délais de livraison rapides, vous pouvez avoir une allure distincte et européenne.

# MOTHER NATURE MÈRE NATURE



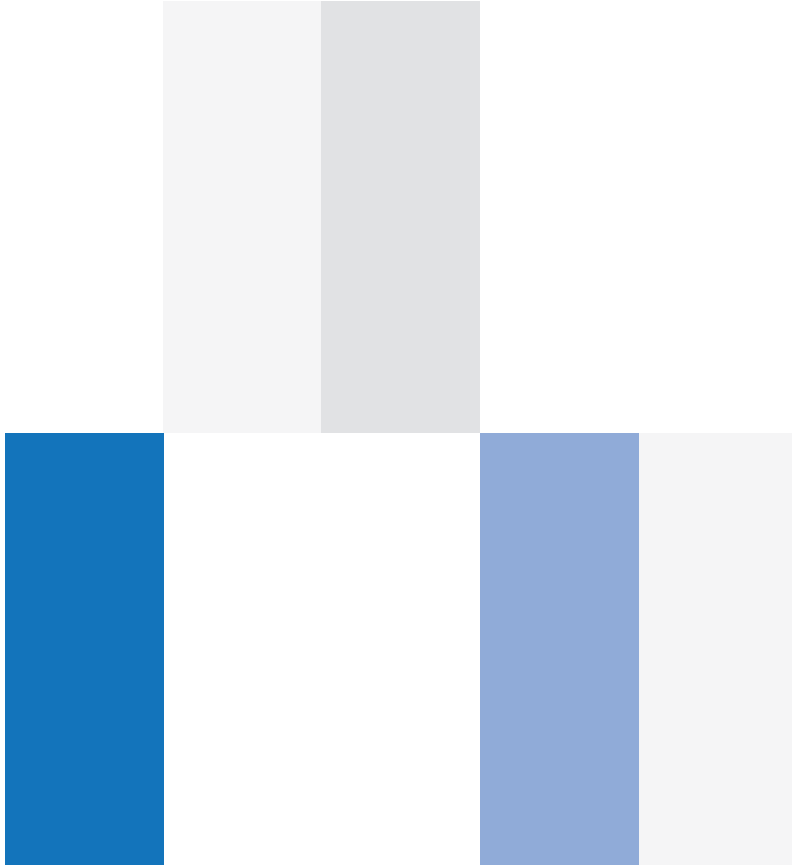

Being close benefits the environment as well as our customers. Choose MIMO and you'll get LEED points for everything from sourcing within 500 miles to using recyclable materials and increasing access to natural light. And of course, by using MIMO's slender frame to create open, modern, graceful interiors, you'll make fans of each person using the space every day.

19

L'utilisation des cloisons MIMO peut vous permettre d'obtenir des points LEED dans 9 catégories, selon le type de matériaux que vous utilisez. Étant conçues et fabriquées chez nous, vous demeurez dans la zone des 800 kilomètres pour l'utilisation de matériaux régionaux. Vous utilisez des matériaux recyclables et vous augmentez l'accès de la lumière dans votre environnement. Et, bien sûr, parce que vous utilisez les fines extrusions MIMO, vous créez des espaces ouverts, modernes, et "chics" qui créeront un impact positif sur vos employés et votre clientèle, à tous les jours.





MAGNI  
FICIENT  
MAGNI  
FIQUE



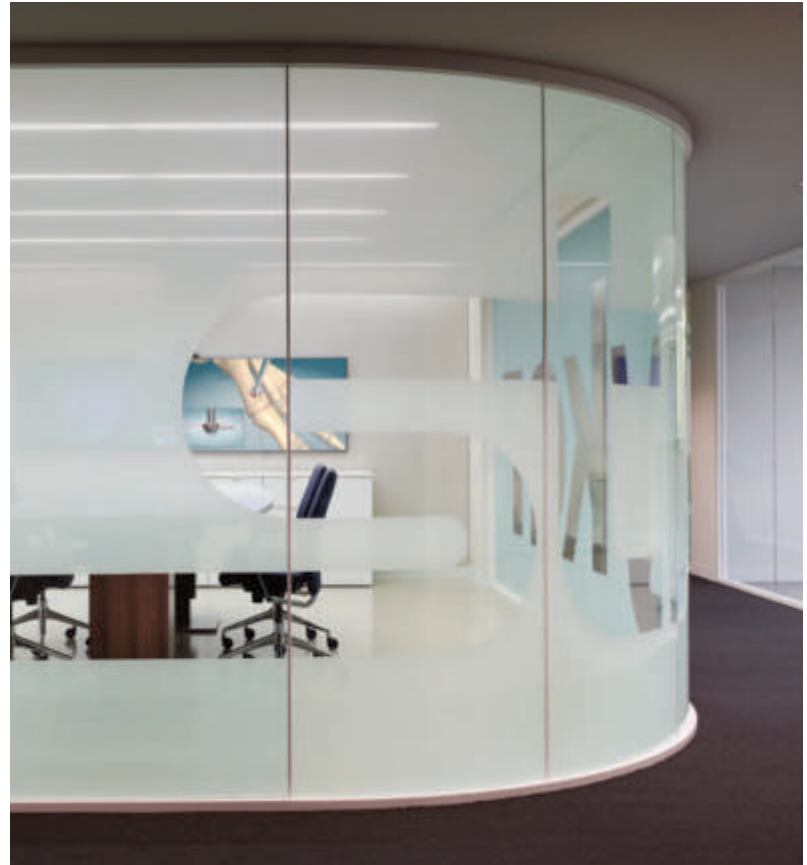











**DET  
AILS  
DET  
AILS**

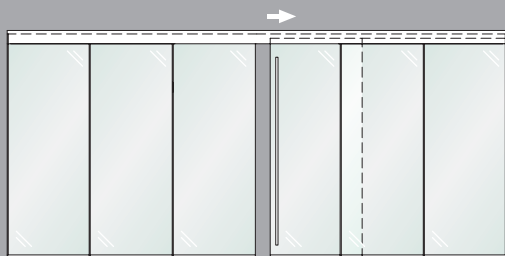

**GLASS SLIDING DOORS** SINGLE OR MULTIPLE  
**PORTE EN VERRE COULISSANTE** SIMPLE OU MULTIPLE

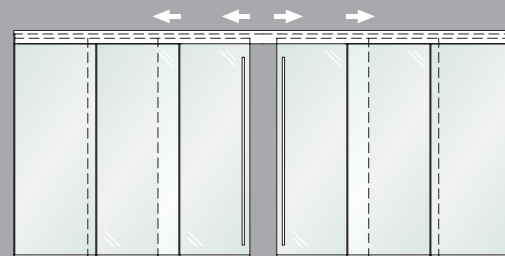
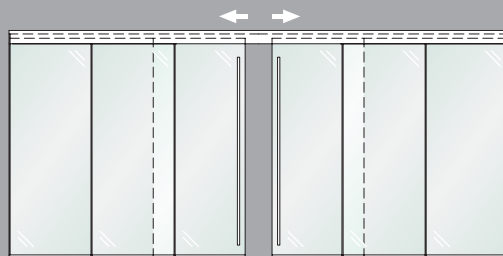

**GLASS PIVOT/HINGE DOORS** SINGLE GLAZING  
**PORTE EN VERRE PIVOTS/CHARNIÈRES** VERRE SIMPLE

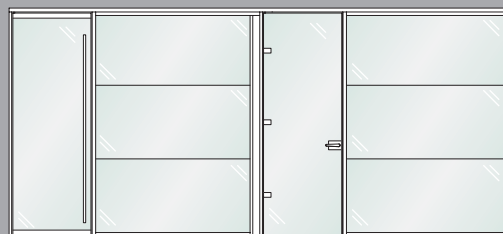

**WOOD HINGE DOORS** SINGLE GLAZING  
**PORTE EN BOIS SUR CHARNIÈRES** VERRE SIMPLE



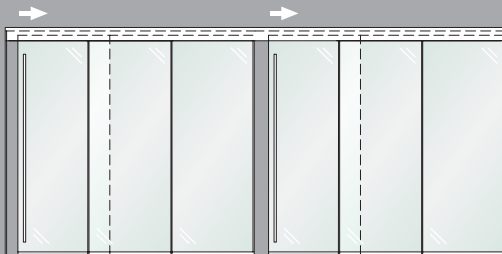

**SHAPE VERSATILITY**  
VERSATILITÉ DE FORME



**MATERIAL VERSATILITY**  
VERSATILITÉ DE MATÉRIAUX

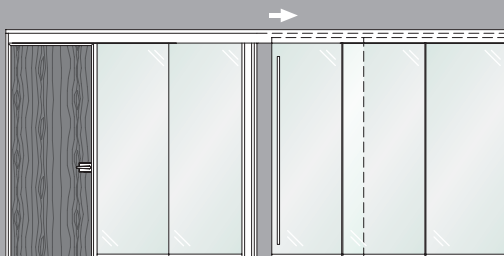

**DOUBLE GLAZED ACOUSTICS**  
**CLOISONS ACOUSTIQUES VERRE DOUBLE**

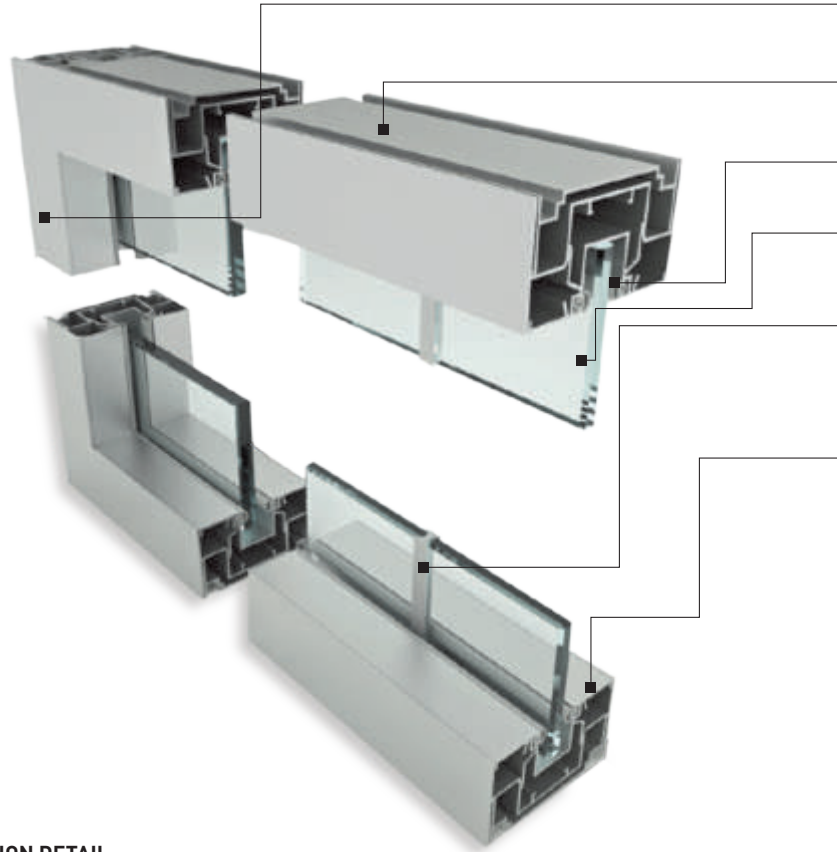

**JAMB MULLION WITH CENTER GLASS ADAPTOR**  
**MENEAU DE JAMBAGE AVEC ADAPTEUR DE VERRE CENTRÉ**

**HEAD MULLION WITH CENTER GLASS ADAPTOR**  
**MENEAU DE TÊTE AVEC ADAPTEUR DE VERRE CENTRÉ**

**ACOUSTIC GASKETS**  
**JOINT ACOUSTIQUE**

**CENTERED SINGLE GLASS**  
**VERRE SIMPLE CENTRÉ**

**ALUMINUM OR POLYCARBONATE TRIM**  
**GLASS TO GLASS JUNCTION**  
**MOULURE EN ALUMINIUM OU EN POLYCARBONATE**  
**JONCTION VERRE CONTRE VERRE**

**SILL MULLION WITH CENTER GLASS ADAPTOR**  
**MENEAU DE LISSE AVEC ADAPTEUR DE VERRE CENTRÉ**

**SECTION DETAIL**  
**DÉTAIL EN COUPE**

# CENTER GLAZED VERRE CENTRÉ

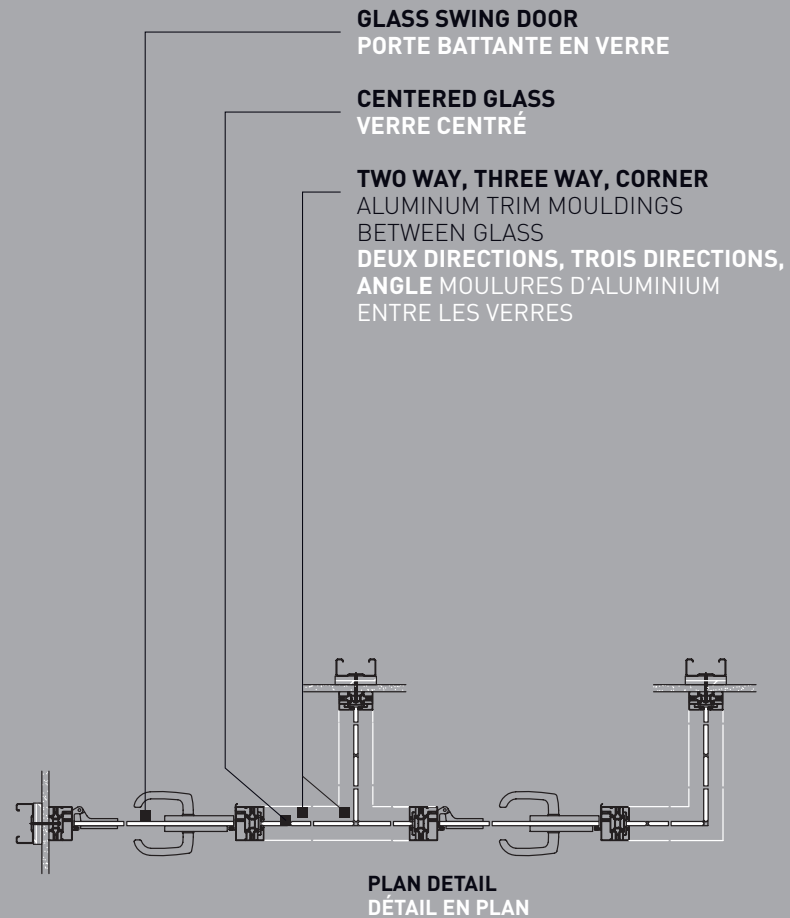
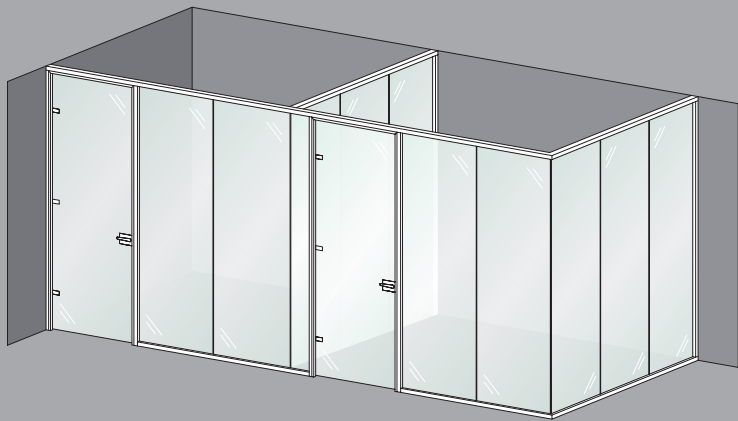



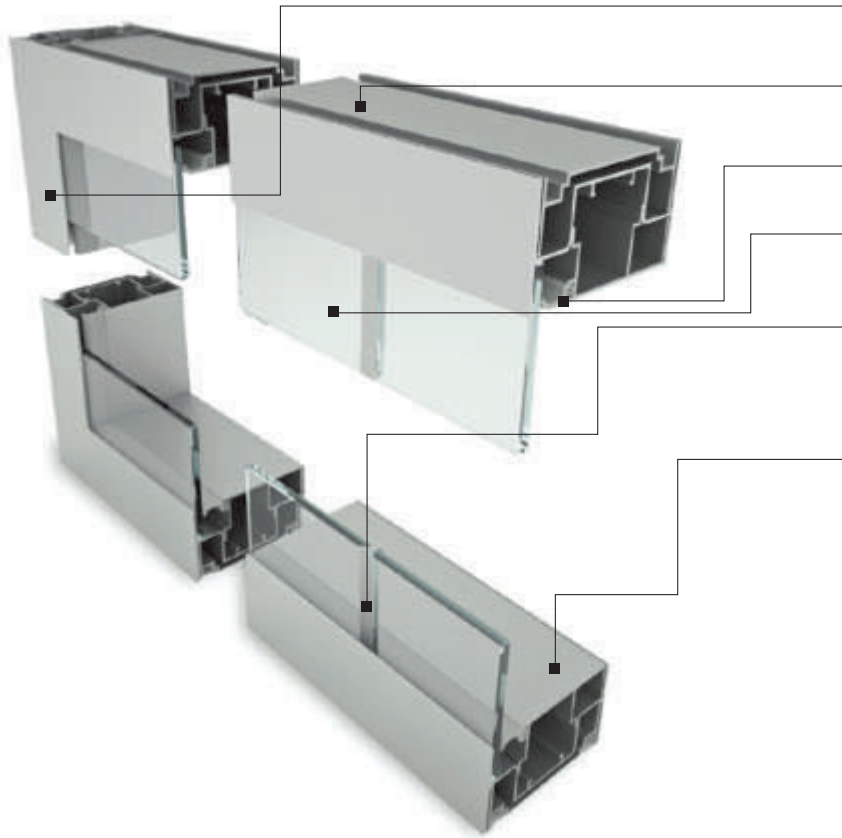

**JAMB MULLION WITH OFFSET GLASS ADAPTOR**  
**MENEAU DE JAMBAGE AVEC ADAPTEUR DE VERRE DÉCENTRÉ**

**HEAD MULLION WITH OFFSET GLASS ADAPTOR**  
**MENEAU DE TÊTE AVEC ADAPTEUR DE VERRE DÉCENTRÉ**

**ACOUSTIC GASKETS**  
**JOINT ACOUSTIQUE**

**OFFSET SINGLE GLASS**  
**VERRE SIMPLE DÉCENTRÉ**

**ALUMINUM OR POLYCARBONATE TRIM**  
GLASS TO GLASS JUNCTION  
**MOULURE EN ALUMINIUM OU EN POLYCARBONATE**  
JONCTION VERRE CONTRE VERRE

**SILL MULLION WITH OFFSET GLASS ADAPTOR**  
**MENEAU DE LISSE AVEC ADAPTEUR DE VERRE DÉCENTRÉ**

**SECTION DETAIL**  
**DÉTAIL EN COUPE**

# OFFSET GLAZED VERRE DÉCENTRÉ

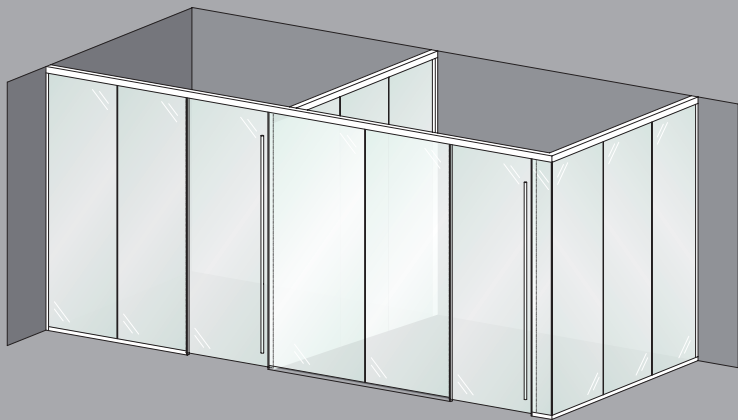

**OFFSET GLASS**  
VERRE DÉCENTRÉ

**SLIDING DOOR GLASS**  
PORTE COULISSANTE EN VERRE

**TWO WAY, THREE WAY, CORNER**  
ALUMINUM TRIM MOULDINGS  
BETWEEN GLASS  
DEUX DIRECTIONS, TROIS DIRECTIONS,  
ANGLE MOULURES D'ALUMINIUM  
ENTRE LES VERRES

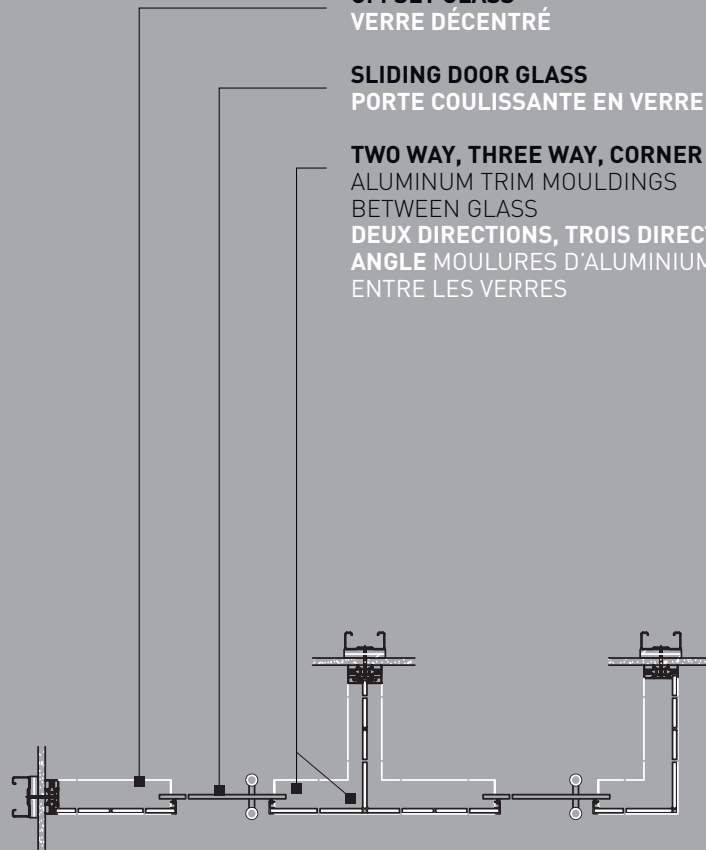

**PLAN DETAIL**  
DÉTAIL EN PLAN

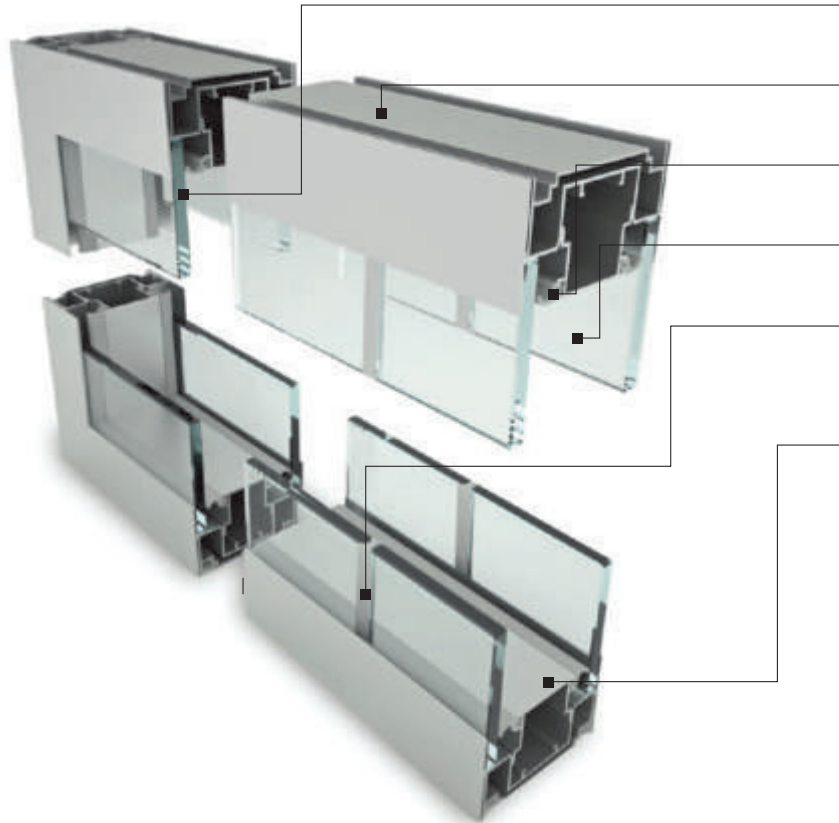

**INSULATED PANELS OR GLASS PANELS**  
PANNEAUX ISOLÉS OU PANNEAUX DE VERRE

**HEAD MULLION WITH SYMMETRICAL OFFSET ADAPTOR**  
MENEAU DE TÊTE AVEC ADAPTEUR SYMÉTRIQUE

**ACOUSTIC GASKETS**  
JOINT ACOUSTIQUE

**DOUBLE GLASS 2 1/2" AIR SPACE**  
DOUBLE VERRE ESPACÉ DE 2 1/2"

**ALUMINUM OR POLYCARBONATE TRIM**  
GLASS TO GLASS JUNCTION  
MOULURE EN ALUMINIUM OU EN POLYCARBONATE  
JONCTION VERRE CONTRE VERRE

**SILL MULLION WITH SYMMETRICAL OFFSET ADAPTOR**  
MENEAU DE LISSE AVEC ADAPTEUR SYMÉTRIQUE

**SECTION DETAIL**  
DÉTAIL EN COUPE

# DOUBLE GLAZED VERRE DOUBLE

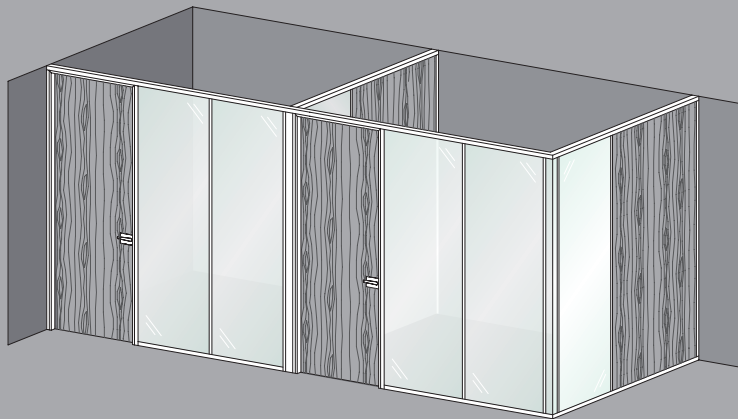

**1 3/4" WOOD DOOR**  
PORTE DE BOIS 1 3/4"

**DOUBLE GLASS 2 1/2" AIR SPACE**  
VERRE DOUBLE ESPACÉ DE 2 1/2"

**INSULATED PANELS**  
PANNEAUX AVEC ISOLANT

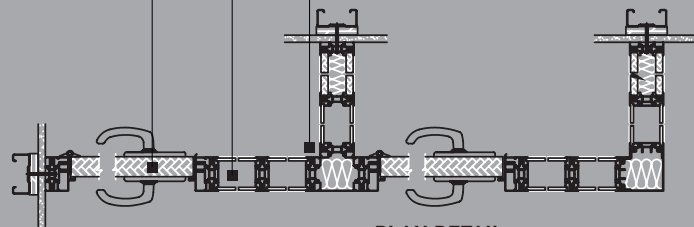

**PLAN DETAIL**  
DÉTAIL EN PLAN



**CENTER GLAZED**  
VERRE CENTRÉ



**OFFSET GLAZED**  
VERRE DÉCENTRÉ



**DOUBLE GLAZED**  
VERRE DOUBLE

# ADJUSTABLE SILL+JAMB LISSE+JAMBAGE AJUSTABLE

Depending on different configurations of the system, MIMO ranges on a total travelling distance of a minimum of 1" to a maximum of 2".

Dépendamment de la configuration du système, MIMO peut atteindre une ajustabilité allant de 1" jusqu'à 2".

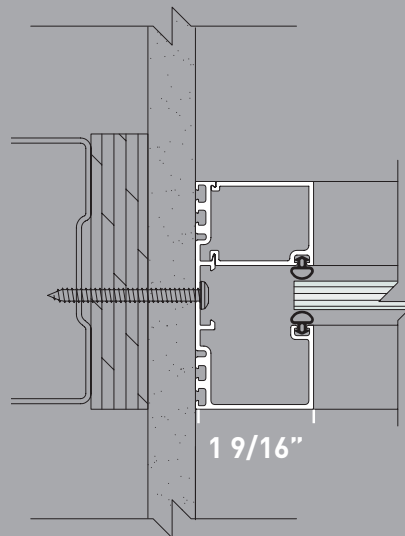
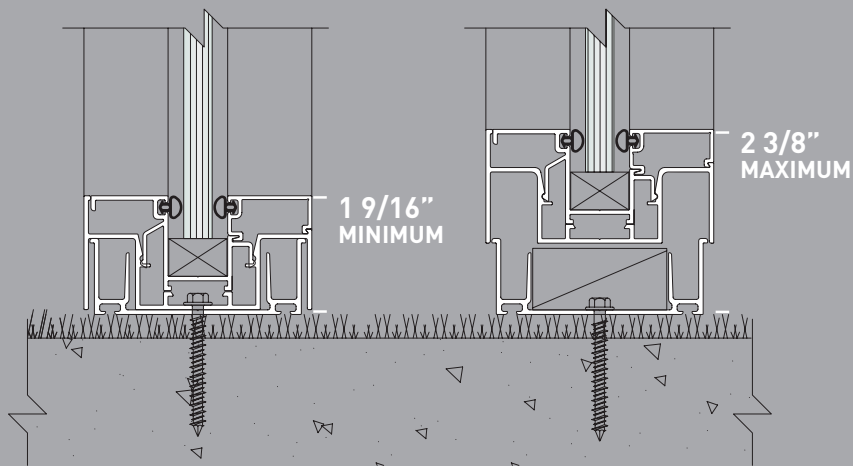



# GLASS JUNCTIONS JONCTIONS DE VERRE

POLYCARBONATE  
POLYCARBONATE

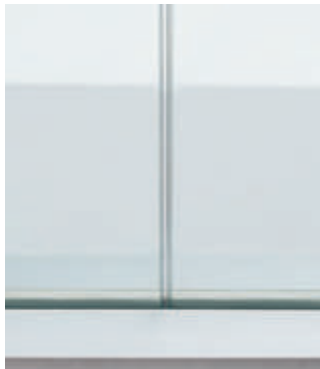

GLASS TO GLASS  
VERRE CONTRE VERRE

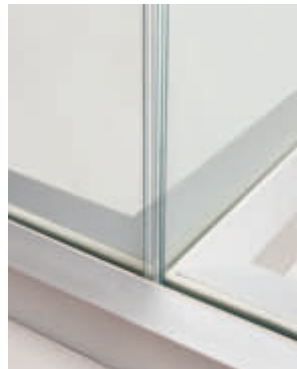

GLASS T-CONDITION  
JONCTION EN T



CORNER CONDITION  
JONCTION EN COIN

ALUMINIUM  
ALUMINIUM



GLASS TO GLASS  
VERRE CONTRE VERRE

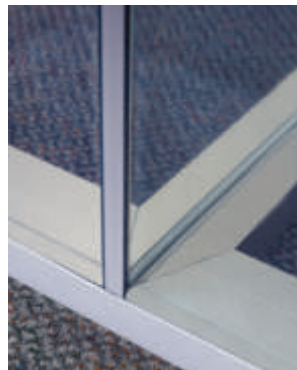

GLASS T-CONDITION  
JONCTION EN T



CORNER CONDITION  
JONCTION EN COIN



# DOOR DETAILS DÉTAILS DES PORTES

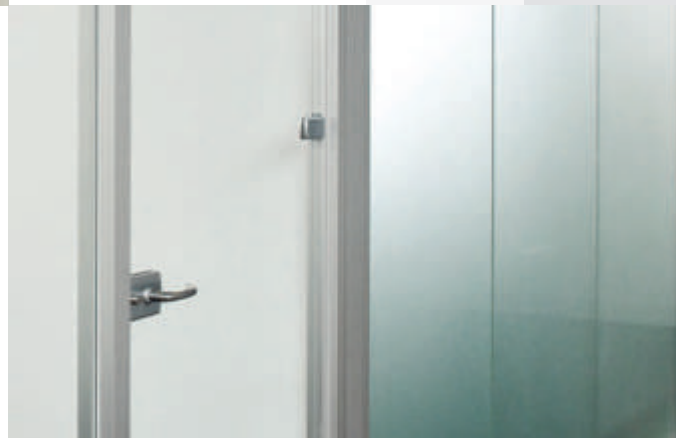
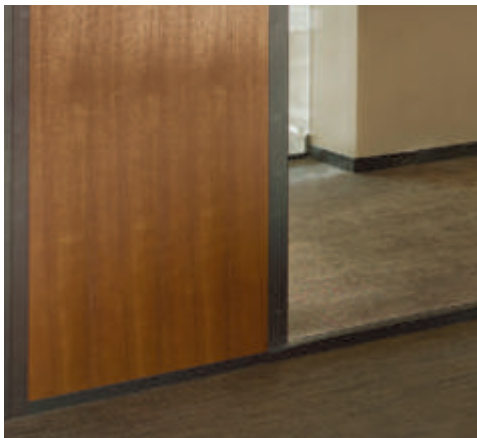
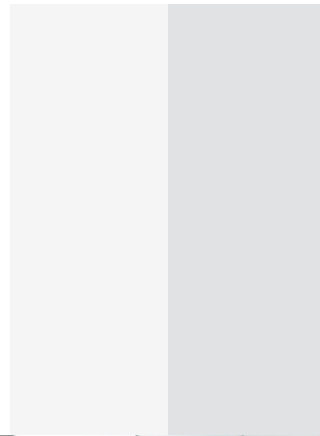

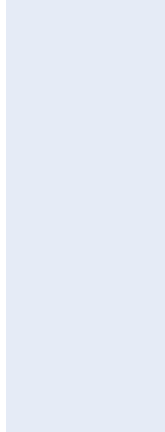
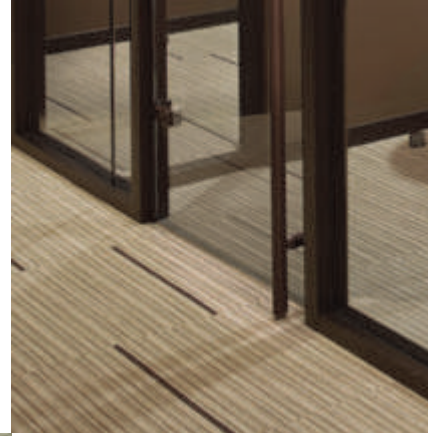





**HARD  
WARE  
QUINCA  
ILLERIE**



MIMO frames and hardware are carefully engineered to exacting standards that provide you with the greatest strength, durability, and reliability, in the slimmest profile possible. Minimal. Modern. It's all in our name.

Les cadres et la quincaillerie MIMO sont conçus avec précision pour assurer un assemblage précis et durable. La finesse de ses lignes, minimales, modernes, s'accordent avec son nom.





# LADDER PULLS POIGNÉES TUBULAIRES + LEVER SETS POIGNÉES À LEVIER

Ladder pulls are available in both square and round profiles and ranging from 7" to 84" in length.

Les poignées tubulaires sont disponibles en profile carré ou rond, et varient entre 7" et 84" en longueur.



**SQUARE  
LADDER PULL  
POIGNÉE  
TUBULAIRE CARRÉE**



**ROUND  
LADDER PULL  
POIGNÉE  
TUBULAIRE RONDE**



**SQUARE LOCKING  
LADDER PULL  
POIGNÉE TUBULAIRE  
CARRÉE VERROUILLABLE**



**ROUND LOCKING  
LADDER PULL  
POIGNÉE TUBULAIRE  
RONDE VERROUILLABLE**



**LEVER SET**  
**MFHDW-027**  
POIGNÉE À LEVIER  
MFHDW-027



**LEVER SET**  
**MFHDW-028**  
POIGNÉE À LEVIER  
MFHDW-028



**LEVER SET**  
**MFHDW-28B**  
POIGNÉE À LEVIER  
MFHDW-28B



**LEVER SET**  
**MFHDW-030**  
POIGNÉE À LEVIER  
MFHDW-030



# LEATHER WRAPPED ENVELOPPÉ DE CUIR



BLACK  
NOIR



BEIGE  
BEIGE



BROWN  
MARRON



RED  
ROUGE



# WOODEN PULLS POIGNÉES EN BOIS



MAHOGANY  
ACAJOU



ASH  
FRÊNE



WENGE  
WENGÉ



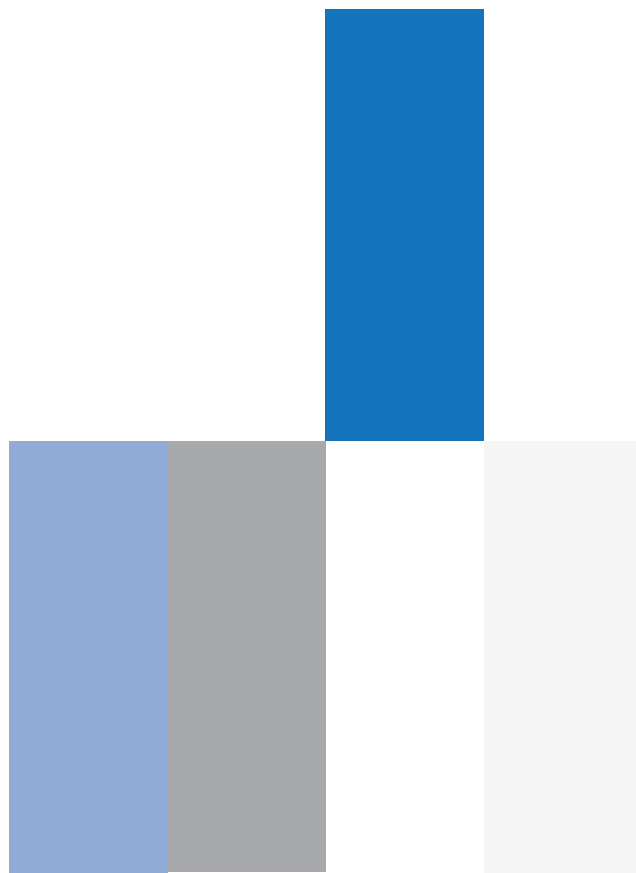



# **muraflex**

5502, Notre-Dame E  
Montréal, Québec  
Canada, H1N 2C4

**T** 1.866.962.3632

**T** 450.462.3632

**F** 450.462.7972

**E** [info@muraflex.com](mailto:info@muraflex.com)

**W** [muraflex.com](http://muraflex.com)

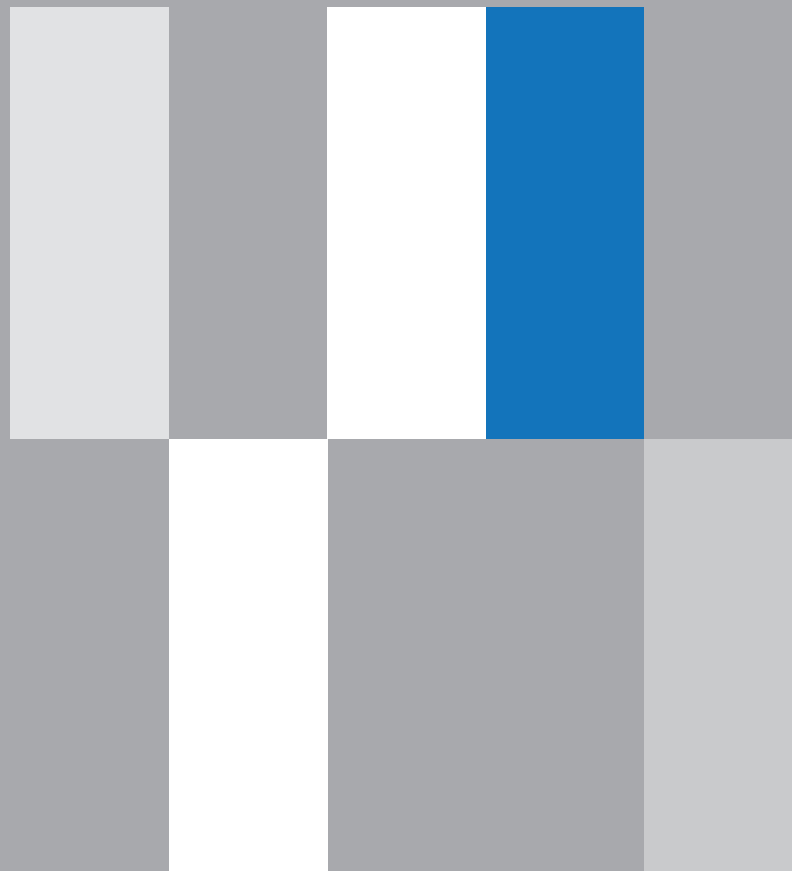



**muraflex**

[muraflex.com](https://muraflex.com)